



ROURA
MATERIAL HANDLING

Michigan: (800) 968-9070

Mississippi: (800) 654-9147

rouramh.com

BEHEMOTH HOPPER MODEL

4T-3/16-EL-2160 8 CU YD



MODEL#	VOLUME	L	W	H	WEIGHT	FORK OPENING	MAX LOAD CAP
4T-3/16-EL-2160	8 Yd ³	91"	109"	70"	2425 LBS	3" X 49-1/2"	8000 LBS

BEHEMOTH 4T-3/16-EL-2160

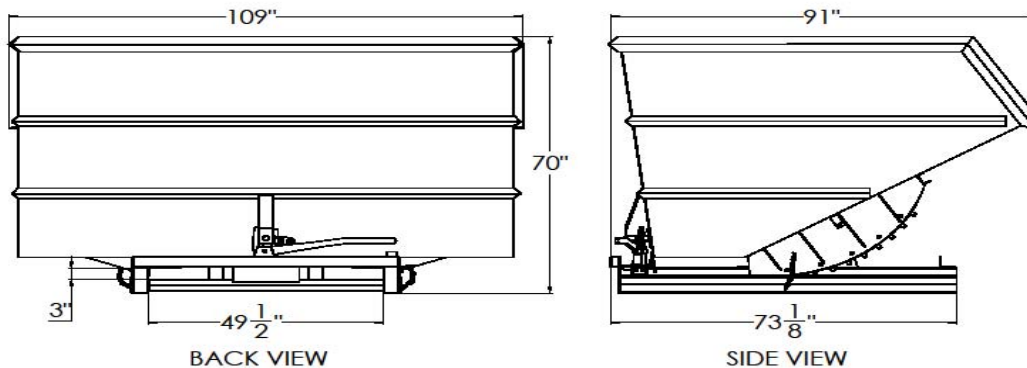

CONSTRUCTION: 3/16" plate body, reinforced with 3 additional rows of reinforcing angle, 5/16" heavy duty boxed tube base, extended Auto-Latch handle, base to body chains, slide bolt latch and continuous stops.

FINISH: Bright safety green enamel paint.

(STEEL COVER & CASTERS ARE NOT AVAILABLE ON ANY BEHEMOTH HOPPER MODELS)